

FCC STATEMENT

This device complies with Part 15 of the FCC Rules. Operation is subject to the following two conditions:

- (1) This device may not cause harmful interference, and
- (2) This device must accept any interference received, including interference that may cause undesired operation.

Note:

This equipment has been tested and found to comply with the limits for Class B digital devices, pursuant to Part 15 of the FCC rules. These limits are designed to provide reasonable protection against harmful interference in a residential installation. This equipment generates uses and can radiate radio frequency energy and, if not installed and used in accordance with the instructions, may cause harmful interference to radio communications. However, there is no guarantee that interference will not occur in a particular installation. If this equipment does cause harmful interference to radio or television reception, which can be determined by turning the equipment off and on, the user is encouraged to try to correct the interference by one or more of the following measures:

- Reorient or relocate the receiving antenna.
- Increase the separation between the equipment and receiver.
- Connect the equipment into an outlet on a circuit different from that to which the receiver is connected.
- Consult the dealer or an experienced radio/TV technician for help.

Use of shielded cable is required to comply with Class B limits in Subpart B of Part 15 of the FCC rules.

Do not make any changes or modifications to the equipment unless otherwise specified in the manual. If such changes or modifications should be made, you could be required to stop operation of the equipment.

READ THIS FIRST

Trademark Information

- Microsoft® and Windows® are U.S. registered trademarks of Microsoft Corporation.
- Pentium® is a registered trademark of Intel Corporation.
- Macintosh is a trademark of Apple Computer, Inc.
- SD™ is a trademark.
- Photo Explorer and Photo Express are trademarks.
- Other names and products may be trademarks or registered trademarks of their respective owners.

Product Information

- Product design and specifications are subject to change without notice. This includes primary product specifications, software, software drivers, and user's manual. This User Manual is a general reference guide for the product.
- The product and accessories that come with your digital camera may be different from those described in this manual. This is due to the fact that different retailers often specify slightly different product inclusions and accessories to suit their market requirements, customer demographics, and geographical preferences. Products very often vary between retailers especially with accessories such as batteries, chargers, AC adapters, memory cards, cables, carrying cases/pouches, and language support. Occasionally a retailer will specify a unique product color, appearance, and internal memory capacity. Contact your dealer for precise product definition and included accessories.
- The illustrations in this manual are for the purpose of explanation and may differ from the actual design of your digital camera.
- The manufacturer assumes no liability for any errors or discrepancies in this user manual.
- For user manual and driver updates, refer to our website or contact your dealer.

SAFETY INSTRUCTIONS

Read and understand all **Warnings** and **Cautions** before using this product.

Warnings

If foreign objects or water have entered the camera, turn the power OFF and remove the batteries and the AC power adapter.

Continued use in this state might cause fire or electric shock. Consult the store of purchase.



If the camera has fallen or its case has been damaged, turn the power OFF and remove the batteries and the AC power adapter.

Continued use in this state might cause fire or electric shock. Consult the store of purchase.



Do not disassemble, change or repair the camera.

This might cause fire or electric shock. For repair or internal inspection, ask the store of purchase.



Use the supplied AC adapter only with the indicated power supply voltage.

Use with any other power supply voltage might cause fire or electric shock.



Do not use the camera in areas near water.

This might cause fire or electric shock. Take special care during rain, snow, on the beach, or near the shore.



Do not place the camera on inclined or unstable surfaces.

This might cause the camera to fall or tilt over, causing injury.



Keep the batteries out of the reach of children.

Swallowing batteries might cause poisoning. If the battery is accidentally swallowed, immediately consult a physician.



Do not use the camera while you are walking, driving or riding a motorcycle.

This might cause you to fall over or result in traffic accident.



Cautions

Insert the batteries paying careful attention to the polarity (+ or –) of the terminals.

Inserting the batteries with its polarities inverted might cause fire and injury, or damage to the surrounding areas due to the battery rupturing or leaking.



Do not fire the flash close to anyone's eyes.

This might cause damage to the person's eyesight.



Do not subject the LCD monitor to impact.

This might damage the glass on the screen or cause the internal fluid to leak. If the internal fluid enters your eyes or comes into contact with your body or clothes, rinse with fresh water. If the internal fluid has entered your eyes, consult a physician to receive treatment.



A camera is a precision instrument. Do not drop it, strike it or use excessive force when handling the camera.

This might cause damage to the camera.



Do not use the camera in humid, steamy, smoky, or dusty places.

This might cause fire or electric shock.



Do not remove the battery immediately after long period of continuous use.

The battery becomes hot during use. Touching a hot battery might cause burns.



Do not wrap the camera or place it in cloth or blankets.

This might cause heat to build up and deform the case, resulting in fire. Use the camera in a well-ventilated place.



Do not leave the camera in places where the temperature may rise significantly, such as inside a car.

This might adversely affect the case or the parts inside, resulting in fire.



Before you move the camera, disconnect cords and cables.

Failure to do this might damage cords and cables, resulting in fire and electric shock.



Notes on Battery Usage

When you use the battery, carefully read and observe the **Safety Instructions** and the notes described below:

- Different battery types and surrounding temperatures may affect the battery performance.
- Avoid using batteries in extremely cold environments as low temperatures can shorten the battery life and reduce camera performance. This low temperature will also influence Alkaline battery performance, therefore Ni-MH rechargeable battery is highly recommended.
- If you are using the new rechargeable batteries or rechargeable batteries that have not been used for an extended period of time (batteries that pass the expiry date are exceptions) might affect the number of pictures that can be taken. Therefore, to maximize their performance and lifetime, we recommend that you fully charge the batteries and discharge them for at least one complete cycle before use.
- The battery may feel warm when using the camera for an extended period of time or using the flash continuously. This is normal and not a malfunction.
- The camera may feel warm when being used continuously or for an extended period of time. This is normal and not a malfunction.
- If you will not be using the batteries for an extended period of time, remove them from the camera to prevent leakage or corrosion.
- Never use batteries of different types (together) or mix old and new batteries.
- Always keep the terminals in a clean state.
- Never use manganese batteries.
- Risk of explosion if battery is replaced by an incorrect type.
- Dispose of used batteries according to the instructions.

CONTENTS

INTRODUCTION	8	PHOTOGRAPHY MODE.....	23
Package Contents.....	9	Shooting Images - The Basics.....	23
GETTING TO KNOW YOUR CAMERA.....	10	Setting Image Resolution and Quality	24
Front View.....	10	Using the Zoom Function.....	25
Rear View.....	11	Using the Flash.....	26
Mode Dial	12	Using the Self-Timer.....	27
LCD Monitor Information.....	13	Adjusting the Exposure (EV Compensation).....	28
PREPARING THE CAMERA.....	15	Setting White Balance.....	29
Installing the Batteries	15	USING THE MODE DIAL.....	30
Using the AC Power Adapter.....	16	Auto Mode.....	30
Inserting and Removing an SD Memory Card.....	17	Program Mode	30
Attaching the Camera Strap.....	18	Portrait Mode.....	31
LED Indicators.....	18	Landscape Mode.....	31
GETTING STARTED.....	19	Sport Mode.....	32
Turning the Power On/Off	19	Night Mode.....	32
Choosing the Screen Language.....	19	ADVANCED SHOOTING.....	33
Setting the Date and Time	20	Burst.....	33
Formatting an SD Memory Card or Internal		Auto Exposure Bracketing (AEB)	34
Memory.....	21	Selecting the Metering Mode	35
Using the LCD Monitor.....	22		

PLAYBACK MODE - THE BASICS.....	36	EDITING SOFTWARE INSTALLATION.....	56
Viewing Images	36	Installing Photo Explorer.....	56
Magnifying Images	37	Installing Photo Express.....	57
Thumbnail Display	38	USING THE DIGITAL CAMERA AS A PC CAMERA...58	
Slideshow Display	39	Step 1: Install the PC camera driver.....	58
Resizing an Image	40	Step 2: Connect the digital camera to your computer.....	59
VIDEO MODE.....	41	Step 3: Run your application software (i.e. Windows NetMeeting).....	59
Recording Video Clips	41	MENU OPTIONS.....	60
Playing Back Video Clips	42	Camera Menu.....	60
PLAYBACK MODE – ADVANCED FEATURES...43		Video Menu	64
Playing Back Still Images/Video Clips on TV	43	Playback Menu.....	65
Deleting Images/Video Clips.....	44	Setup Menu.....	67
Protecting Images/Video Clips	45	CONNECTING THE DIGITAL CAMERA TO OTHER DEVICES.....	70
Setting the DPOF.....	46	SPECIFICATIONS.....	71
Connecting to a PictBridge Compliant Printer.....	48	APPENDIX.....	72
TRANSFERRING FILES FROM YOUR DIGITAL CAMERA TO COMPUTER.....	52		
Step 1: Install the USB driver	53		
Step 2: Connect the digital camera to your computer.....	54		
Step 3: Download images or video clips.....	55		

INTRODUCTION

Thank you for purchasing the new digital camera!

Equipped with a 5.0 Megapixels CCD sensor, your camera delivers good quality, 2560 x 1920 resolution images. Other features provided by the camera include the following:

■ 5.0 Megapixels

A high-resolution CCD sensor provides 5.0 megapixels for good quality of images.

■ Auto flash

An auto flash sensor automatically detects the shooting (lightening) conditions and determines whether the flash should be used.

■ 2.5" LTPS color image LCD monitor

■ Optical zoom: 1x~3x

■ Digital zoom: 1x~4x

■ 16MB internal (built-in) memory

Images can be captured without using a memory card.

■ Support for SD memory card for memory expansion

You may wish to expand the memory capacity (up to 512MB capacity) by using an external memory card.

■ USB connection (USB 1.1 compliant)

Still images, video clips, or voice recording files that you have recorded can be downloaded to your computer using the USB cable (A USB driver is required for Win 98 and Win98SE).

■ DPOF functionality

DPOF can be used to print your images on a DPOF compatible printer by simply inserting the memory card.

■ PictBridge support

You can connect the camera directly to printer that supports PictBridge and perform image selection and printing using the camera monitor screen and controls.

■ Provided editing software: Photo Explorer / Photo Express

You can enhance and retouch your images on your computer by using the provided editing software.

Package Contents

Carefully unpack your kit box and ensure that you have the following items. In the event that any item is missing or if you find any mismatch or damage, promptly contact your dealer.

Common Product Components:

- Digital Camera
- User's Manual
- USB Cable
- Software CD-ROM
- AV Cable
- Camera Strap
- Camera Pouch
- Warranty card

GETTING TO KNOW YOUR CAMERA

Front View

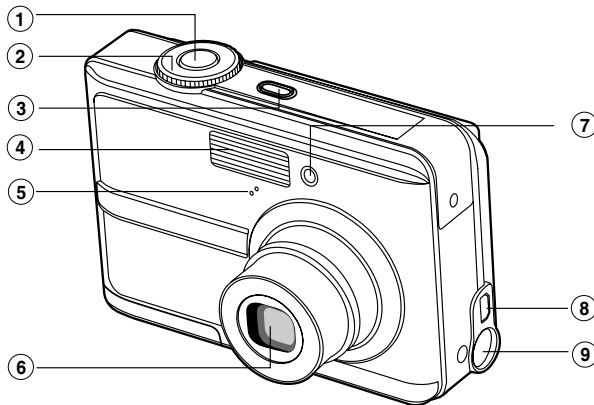

1. Shutter button

2. Mode dial

3. Power button (ON/OFF)

4. Flash

5. Microphone

6. Lens

7. Self-timer LED

8. PC (USB) / AV Out terminal

9. DC in 3V terminal

Rear View

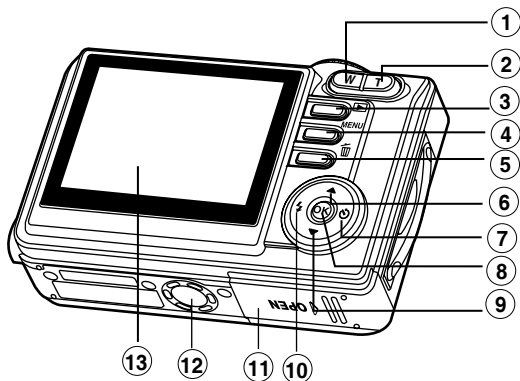

- | | |
|----------------|------------------------------|
| 1. W | Zoom out (wide-angle) button |
| | Thumbnail button |
| 2. T / | Zoom in (telephoto) button |
| 3. | Rec-play button |
| 4. MENU | Menu button |
| 5. | Delete button |
| 6. | Arrow button (Up) |
| 7. | Arrow button (Right) |
| | Self-timer button |

- | | |
|--------------|-------------------------|
| 8. OK | OK / Display button |
| 9. | Arrow button (Down) |
| 10. | Arrow button (Left) |
| | Flash button |
| 11. | Battery / SD card cover |
| 12. | Tripod socket |
| 13. | LCD monitor |

Mode Dial

You can select from seven shooting modes and setup mode according to shooting conditions to achieve the desired effect.

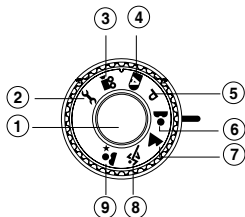

	Mode	Description
1.		Shutter button Press to capture the images.
2.		Setup Select this mode to adjust the camera settings.
3.		Video Select this mode to record video clips.
4.	A	Auto Select this mode to adjust point-and-shoot action.
5.	P	Program Select this mode to permit the shutter speed and aperture to be set manually.
6.		Portrait Select this mode to make people stand out with the background out-of-focus.
7.		Landscape Use this mode to take phototgraphs of distant scenery or landscapes.
8.		Sports Use this mode to shoot fast moving objects.
9.		Night Select this option to take phototgraphs of people against a dusk or night-time background.

LCD Monitor Information

■ Camera Mode

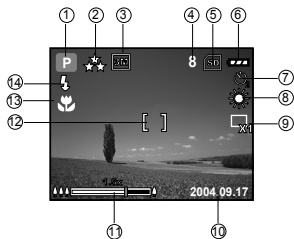

1. Mode indication

- [**A**] Auto Mode
- [**S**] Setup Mode
- [**V**] Video Mode
- [**L**] Landscape Mode
- [**P**] Program Mode
- [**S**] Sports Mode
- [**PT**] Portrait Mode
- [**N**] Night Mode

2. Image quality

- [*******] FINE
- [******] NORMAL
- [*****] ECONOMY

3. Image size

- [**5M**] 2560 x 1920
- [**3M**] 2048 x 1536
- [**1.2M**] 1280 x 960
- [**0.5M**] 640 x 480





4. Possible number of shots

5. Internal memory/SD memory card indicator





[] Status of internal memory

[] Status of SD memory card



6. Remaining battery status



- [] Full battery power
- [] Medium battery power
- [] Low battery power
- [] No battery power

7. Self-timer mode



- [] OFF
- [] 2 sec. delay
- [] 10 sec. delay
- [] 10+2 sec. delay

8. White balance

- [] DAYLIGHT
- [] CLOUDY

- [] SUNSET
- [] TUNGSTEN
- [] FLUORESCENT

9. Capture mode indicator

- [] SINGLE
- [] BURST
- [] AEB







10. Date

11. Zoom stat

12. Focus area

13. Focus indicator (no indication for auto focus)

14. Flash mode

- [] AUTO
- [] MACRO
- [] INFINITY
- [] Auto Flash (Default)
- [] Red Eye
- [] Forced flash
- [] No Flash

■ Video Mode

1. Video mode
2. Recordable movie time available
3. SD memory card indicator (if present)
4. Battery power indicator
5. Focus area
6. Flash mode



■ Image Playback

1. Playback mode
2. SD memory card indicator (if present)
3. Battery power indicator
4. Playback information



■ Video Playback

1. Playback mode
2. Video mode
3. Total of recorded time
4. SD memory card indicator (if present)
5. Battery power indicator
6. Playback indicator
7. Playback information



PREPARING THE CAMERA

Installing the Batteries

You can use 2 AA size batteries to power the camera. Make sure that the power of the digital camera is off before inserting or removing the batteries.

1. Make sure the camera is turned off.
2. Open the battery cover.
3. Insert the batteries in the correct orientation as shown in the illustration.
4. Close the battery cover.
 - To remove the batteries, turn the camera off before removing batteries and hold the camera with the battery cover facing upward, then open the battery cover.

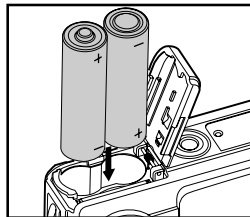

-
- Be careful not to drop the batteries when opening or closing the battery cover.

Using the AC Power Adapter

Use of the AC power adapter is recommended if you intend to use the LCD monitor for a long time or connect the camera to a PC.

1. Make sure your camera is turned off.
2. Connect one end of the AC power adapter to the camera jack labeled "DC IN 3.0V".
3. Connect the other end to an electrical outlet.

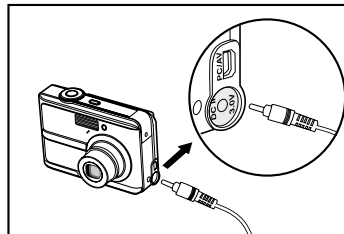

- Make sure to use only the AC power adapter specified for the camera. Damage caused by the use of an incorrect adapter is not covered under the warranty.
- To prevent unexpected auto power off resulting from no battery power left during the process of transferring your images to the computer, use the AC power adapter as a power supply.
- The AC power adapter can only be used to power the camera. Batteries cannot be charged inside the camera.

Inserting and Removing an SD Memory Card

The digital camera comes with 16MB of internal memory, allowing you to store captured still images or video clips in the digital camera. Moreover, you can also expand the memory capacity by using an optional SD (Secure Digital) memory card so that you can store more files.

1. Make sure your camera is turned off before inserting or removing a memory card.
2. Open the SD memory card cover.
3. Insert an SD memory card in the correct orientation as shown in the illustration.
4. Close the battery/SD memory card cover.
 - To remove the SD memory card, make sure the camera is turned off. Press lightly on the edge of the memory card and it will eject.

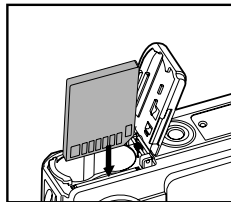

- Be sure to format an SD memory card with this digital camera before using it. Refer to section in the manual titled **“Formatting an SD Memory Card or Internal Memory”** for further details.
- To prevent valuable data from being accidentally erased from an SD card, you can slide the write protect tab (on the side of the SD memory card) to “LOCK”.
- To save, edit, or erase data on an SD memory card, you must unlock the card.

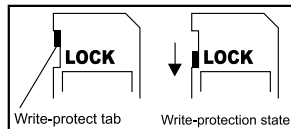

Attaching the Camera Strap

Attach the strap as shown in the illustration.

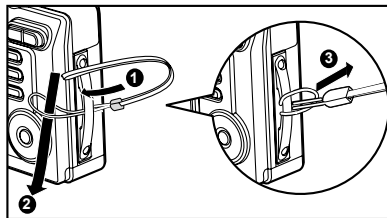

LED Indicators

Indicator	State	Description/Activity
LED indicator	Blinking blue	USB communication/transfer in progress
Self-timer indicator	Blinking blue	The self-timer function is activated.

GETTING STARTED

Turning the Power On/Off

- Press the power (ON/OFF) button until the digital camera turns on.
- To turn the power off, press the power (ON/OFF) button again.

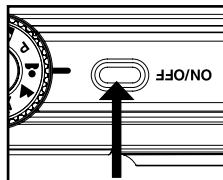

Choosing the Screen Language

Follow the steps below to choose the desired language.

1. Rotate the mode dial to *f* and turn your camera on by pressing the power (ON/OFF) button.
2. Press **▶** to select the [CUSTOM] menu.
3. Use **▼** to select [LANGUAGE], then press the **OK** button.
4. Use **▲** or **▼** to select the language you want.
5. Press the **OK** button to confirm.



Setting the Date and Time

Follow the steps below to set the date display style, current date and time.

1. Rotate the mode dial to \mathcal{f} and turn your camera on by pressing the power (ON/OFF) button.
2. Press \blacktriangleright to select the [CUSTOM] menu.
3. Use \blacktriangledown to select [DATE & TIME], then press the OK button.
 - You may press \blacktriangleleft or \blacktriangleright to switch the date types.
4. Press the \blacktriangleleft / \blacktriangleright buttons to select Year, Month, Day and Time fields.
 - To increase a value, press the \blacktriangle button.
 - To decrease a value, press the \blacktriangledown button.
 - The time is displayed in 24-hours format.
5. Press the OK button after all fields are set.

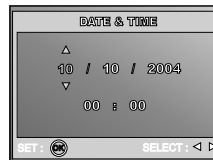

Formatting an SD Memory Card or Internal Memory

The term “Formatting” means preparing an “SD Memory Card” to record images; this process is also called “initialization”. This utility formats the internal memory (or memory card) and erases all stored images and data.

1. Rotate the mode dial to \mathcal{F} and turn your camera on by pressing the power (ON/OFF) button.
 - The [BASIC] menu is displayed.
2. Use \blacktriangledown to select [FORMAT], then press the OK button.
3. Use \blacktriangle or \blacktriangledown to select [YES], then press the OK button to confirm.

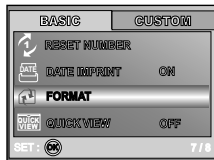

- When you format an SD memory card, be aware that all data of which will be permanently erased. Protected images are also erased.
- To format the internal memory, do not insert a memory card into the camera. Otherwise, you will format the memory card.
- Formatting is an irreversible action and data cannot be recovered at a later time.
- An SD memory card having any problem cannot be properly formatted.

Using the LCD Monitor

Your camera is equipped with a 2.5" full color TFT LCD monitor to help you compose images, replay recorded images/video clips or adjust menu settings. The mode icons, text and numbers displayed on the monitor may vary according to the current settings.

1. Rotate the mode dial to **A**, **P**, **⊙**, **▲**, **⚡**, **⊙*** or **📹**.
2. Press the power (ON/OFF) button to turn on the power.
3. Compose your scene on the LCD monitor.
4. Press the shutter button.

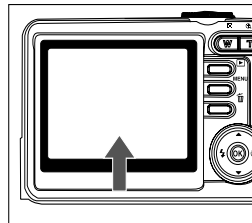

- The LCD monitor darkens in strong sunlight or bright light. This is not a malfunction.
- To prevent your images from being blurred while pressing the shutter button, always hold it carefully. This is especially important when you are shooting under low lighting conditions, which your camera may decelerate the shutter speed to ensure your images are properly exposed.

PHOTOGRAPHY MODE

Shooting Images - The Basics

1. Rotate the mode dial to **A** , **P** , **Ⓜ** , **▲** , **📷** or **Ⓜ*** and turn your camera on by pressing the power (ON/OFF) button.
2. Compose the image on the monitor screen so that the main subject is within the focus frame.
3. Press the shutter button down half way to focus the image.
 - When you press the shutter button down half way, the camera's Auto Focus feature automatically focuses the image and exposure.
4. Press the shutter button the rest of the way down to capture the image.









-
- The actual captured image appears to be larger than the one on LCD after image captured.
 - Pressing the **|◻|** button switches the LCD monitor display mode. Each time you press the **|◻|** button, the display changes in the following order: Focus Frame On → Indicators Off → Composition Line On → LCD Off.

Setting Image Resolution and Quality

As you get to know the digital camera, you can set the image resolution (number of vertical and horizontal pixels) and image quality (compression ratio) based on the types of images you want to shoot. These settings affect the number of images that can be stored in memory, or on a memory card.

Higher resolution and higher quality images provide finer detail but cause the images' file size to be larger.

To change image resolution or image quality, perform these steps below:

1. Rotate the mode dial to **A**, **P**, , ,  or  and turn your camera on by pressing the power (ON/OFF) button.
2. Press the **MENU** button.
 - The [PICTURE] menu is displayed.
3. Use **▼** to select [IMAGE SIZE], then press the  button.
4. Use **▲** or **▼** to select the desired setting, then press the  button to confirm.
5. Follow the step 3 and 4 above to set the [QUALITY].



- The possible number of shots and recording time depend on the storage size, resolution and quality settings and the subject of the image to be captured.
- You can resize the images later. (Please refer to section in this manual titled "**Resizing an Image**" for further detail.)

Using the Zoom Function

This camera is equipped with 3x optical zoom. The lens moves during the optical zoom photography, allowing you to capture telephoto and wide-angle shots. By using the optical zoom function; images appear closer by pressing the **T** button, or smaller away by pressing the **W** button.

Moreover, you can further enlarge the subjects with 4x digital zoom by pressing continuously the **T** button. It is activated after your camera reaches its maximum optical zoom factor (3x). A useful feature as it is, however, the more the image is magnified, the grainer the image may become.

To capture a zoomed image, perform the following steps:



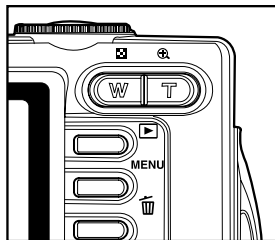



1. Press the power (ON/OFF) button to turn on the power.
2. Adjust the magnification ratio by using the **T / W** button.
 - To access the optical zoom function, press the **T** button as far as it can go. Press it again to activate the digital zoom.
 - To exit the zoom photography, press continuously the **W** button.
 - The status of digital magnification is displayed on the LCD monitor.
3. Compose your scene and press the shutter button.



- The digital magnification ranges from 1.0x to 4.0x.
- As you record video clips, the zoom function cannot be activated.

Using the Flash



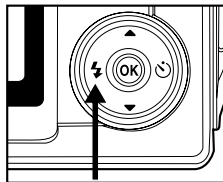

The flash is designed to function automatically when lighting conditions warrant the use of flash. You can take an image using a desired flash mode to suit your circumstances.

1. Rotate the mode dial to **A**, **P**, , ,  or .
2. Press the power (ON/OFF) button to turn on the power.
3. Toggle  /  until your desired flash mode appears on the LCD monitor.
4. Compose your scene and press the shutter button.









The camera has four flash modes: Auto Flash (default), Red Eye, Forced Flash and No Flash.

The table below will help you to choose the appropriate flash mode:

Flash mode	Description
 AUTO FLASH	The flash fires automatically according to suit the photographic conditions.
 RED EYE	Use this mode to reduce the red-eye phenomenon when you want to take natural-looking photographs of people and animals in low-light conditions. When taking photographs, the red-eye phenomenon can be reduced by asking the subject (person) to look at the digital camera or get as close to the digital camera as possible.
 FORCED FLASH	The flash will always fire regardless of the surrounding brightness. Select this mode for recording images with high contrast (backlighting) and deep shadows.
 NO FLASH	Use this mode in the environment that the flash use is prohibited or under the situation that the distance to the subject is too far away for the flash to have any effect.

Using the Self-Timer

The self-timer can be used in situations such as group shots. When using this option, you should either mount the camera on a tripod (recommended) or rest it on a flat, level surface.

1. Secure the camera to a tripod or place it on a stable surface.
2. Rotate the mode dial to **A**, **P**, , ,  or .
3. Press the power (ON/OFF) button to turn on the power.
4. Toggle  /  until your desired self-timer mode appears on the LCD monitor.

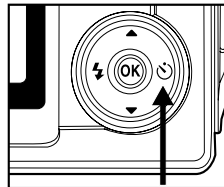
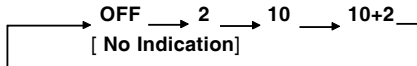









5. Compose your scene and press the shutter button.
 - The self-timer function is activated.
 - The photography is then taken after the preset time.
 - To cancel the self-timer at any time, press the power (ON/OFF) button, switch the mode dial to another mode or press  to disrupt the sequence.



- After one shot is taken, the self-timer mode is turned off.
- If you wish to take another image using the self-timer, repeat these steps.

Adjusting the Exposure (EV Compensation)





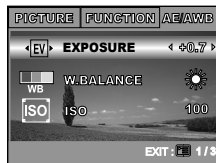





You can manually adjust the exposure determined by the digital camera. Use this mode when the proper exposure cannot be obtained, for example, when the contrast (different between light and dark) between the subject and the background is extremely large. The EV compensation value can be set in the range from -2.0EV to $+2.0\text{EV}$.

1. Rotate the mode dial to **P** ,  ,  ,  or  .
2. Press the power (ON/OFF) button to turn on the power.
3. Press the **MENU** button, then use  to select the [AE/AWB] menu.
4. Use  to select [EXPOSURE], then use  or  to set the range of EV compensation value from -2.0EV to $+2.0\text{EV}$.
5. To exit from the menu, press the **MENU** button.



Setting White Balance

This feature lets you make adjustments to compensate for different lighting types according to your shooting conditions.

1. Rotate the mode dial to **P**, , ,  or .
2. Press the power (ON/OFF) button to turn on the power.
3. Press the **MENU** button, then toggle  to select the [AE/AWB] menu.
4. Use  to select [W. BALANCE], then press the  button.
5. Use  or  to select the desired setting, then press the  button to confirm.
6. To exit from the menu, press the **MENU** button.

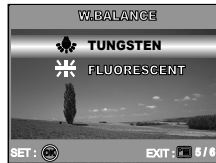
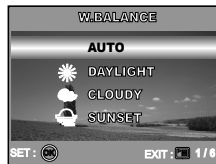

USING THE MODE DIAL

Auto Mode



A (Auto) mode is the simplest way which allows you to take still pictures without having to set special functions or manual adjustments. The camera sets the optimal focusing and exposure.

1. Rotate the mode dial to **A** mode and turn your camera on by pressing the power (ON/OFF) button.
2. Compose your subject within the focus frame.
3. Press the shutter button down halfway to focus the image.
 - When you press the shutter button down half way, the camera's Auto Focus feature automatically focuses the image and exposure.
4. Press the shutter button the rest of the way down to capture the image.



Program Mode



In **P** (Program) mode, the camera automatically sets the shutter speed and aperture for taking still images. You can adjust other functions, such as flash mode or continuous shooting mode.

1. Rotate the mode dial to **P** mode and turn your camera on by pressing the power (ON/OFF) button.
2. Compose your subject within the focus frame.
3. Press the shutter button to capture the image.



Portrait Mode



Select this mode to make people stand out with the background out-of-focus.

1. Rotate the mode dial to  mode and turn your camera on by pressing the power (ON/OFF) button.
2. Compose your subject within the focus frame.
3. Press the shutter button to capture the image.



Landscape Mode



This mode allows you to take photographs of distant scenery or landscapes.

1. Rotate the mode dial to  mode and turn your camera on by pressing the power (ON/OFF) button.
2. Compose your subject within the focus frame.
3. Press the shutter button to capture the image.



Sports Mode



This mode allows you to shoot fast moving objects.

1. Rotate the mode dial to  mode and turn your camera on by pressing the power (ON/OFF) button.
2. Compose your subject within the focus frame.
3. Press the shutter button to capture the image.



Night Mode



This mode allows you to take photographs of people against a dusk or night-time background.

1. Rotate the mode dial to  mode and turn your camera on by pressing the power (ON/OFF) button.
2. Compose your subject within the focus frame.
3. Press the shutter button to capture the image.



ADVANCED SHOOTING

Burst

This mode is used for continuous shooting. Pictures are taken continuously while the shutter release button is pressed.

1. Rotate the mode dial to **P**, **Ⓜ**, **▲**, **📷** or **Ⓜ*** and turn your camera on by pressing the power (ON/OFF) button.
2. Press the **MENU** button, then use **▶** to select the [FUNCTION] menu.
3. Use **▼** to select [CAPTURE MODE], then press the **OK** button.
4. Use **▲** or **▼** to select [BURST], then press the **OK** button.
5. To exit from the menu, press the **MENU** button.
 - The  indicator is displayed on the monitor screen.
6. Press the shutter button halfway to lock the focus.
7. Press the shutter button all the way to shoot.
 - Shooting will stop when the shutter button is released.

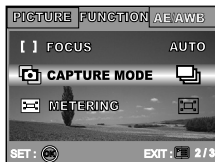

- In Burst mode, the flash mode will be set to **OFF** automatically.

Auto Exposure Bracketing (AEB)

In this mode, the camera automatically changes the exposure within a set range to take three shots after you press the shutter button once. AEB settings can be combined with exposure compensation settings to extend the adjustment range.

1. Rotate the mode dial to **P**, **□**, **▲**, **⚡** or **★** and turn your camera on by pressing the power (ON/OFF) button.
2. Press the **MENU** button, then use **▶** to select the [FUNCTION] menu.
3. Use **▼** to select [CAPTURE MODE], then press the **OK** button.
4. Use **▲** or **▼** to select [AEB], then press the **OK** button.
5. To exit from the menu, press the **MENU** button.
 - The **⚡** indicator is displayed on the monitor screen.
6. Press the shutter button to shoot.



- In AEB mode, the flash mode will be set to **OFF** automatically.

Selecting the Metering Mode

You can select the metering mode that sets which part of the subject to measure to determine the exposure.



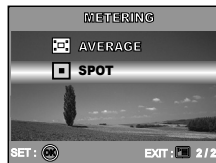
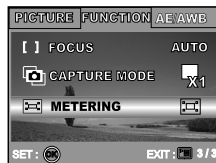

1. Rotate the mode dial to **P**, **Ⓜ**, **▲**, **📷** or **Ⓜ*** and turn your camera on by pressing the power (ON/OFF) button.
2. Press the **MENU** button, then use **▶** to select the [FUNCTION] menu.
3. Use **▼** to select [METERING], then press the **OK** button.
4. Use **▲** or **▼** to select the desired metering mode, then press the **OK** button.
 - [**☐** AVERAGE]: Averages the light metered from the entire frame, but gives greater weight to the subject matter at the center.
 - [**■** SPOT]: Meters the area within the spot automatic exposure point frame at the center of the LCD monitor.
5. To exit from the menu, press the **MENU** button.
6. Compose your subject within the focus frame.
7. Press the shutter button to capture the image.



PLAYBACK MODE - THE BASICS

Viewing Images

You can display the still images you have just captured at a time.



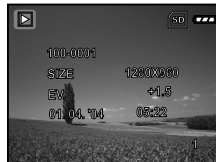



1. Press the power (ON/OFF) button to turn on the camera.
2. Press the  (Playback) button.
 - The last recorded image appears on the LCD monitor.
3. Use  or  to select the desired images.
 - To view the previous image, press the  button.
 - To view the next image, press the  button.



- The playback information displayed on the LCD monitor will disappear after seconds of time.
- If there is no image stored in the internal memory or on the memory card. [NO IMAGE] message will appear on the monitor.

Magnifying Images

While reviewing your images, you may enlarge a selected portion of an image. This magnification allows you to view fine details. The zoom factor displayed on the screen shows the current magnification ratio.



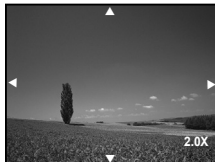





1. Press the  (Playback) button.
 - The last recorded image appears on the LCD monitor.
 - To view the previous image, press the  button.
 - To view the next image, press the  button.
2. Adjust the zoom ration by using the Zoom **T** / **W** button.
 - To enlarge the selected image, press the **T** button.
 - To return to the normal image, press the **W** button.
 - The magnification factor is displayed on the LCD monitor.
3. To view different portion of the images, press the  /  /  /  button to adjust the display area.



- The magnification factors range from 1x to 4x (within 7 stages: 1.0x, 1.5x, 2.0x, 2.5x, 3.0x, 3.5x and 4.0x).

Thumbnail Display



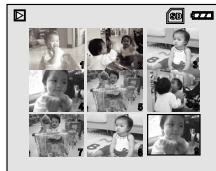

This function allows you to view 9 thumbnail images on the LCD monitor simultaneously so you may search for a particular image.

1. Press the  (Playback) button.
 - The last recorded image appears on the LCD monitor.
2. Press the **W** /  button once.
 - Nine thumbnail images are displayed simultaneously.
 - For recorded video clips, the  video mode icon will be displayed.
3. Use the  /  /  /  button to move the cursor to select the image to be displayed at regular size.
4. Press the  button to display the selected image on full screen.



Slideshow Display

The slide show function enables you to play your images back automatically in sequential order. This is very useful and entertaining feature for reviewing recorded images and for presentations.













1. Press the  (Playback) button.
 - The last recorded image appears on the LCD monitor.
2. Press the **MENU** button, then use **▼** to select [SLIDE SHOW] and press the  button.
3. Use **▲** or **▼** to set the playback interval, then press the  button.
 - The slide show starts.
 - The video clips are displayed the first frame image, and not played back.
 - To stop slide show, press the  button.



- You can adjust the slide show display interval within the range of 3 SEC., 5 SEC., 10 SEC.

Resizing an Image

You can change the image size of a captured image to one of the following sizes: 2560 x 1920 pixel, 2048 x 1536 pixel, 1280 x 960 pixel and 640 x 480 pixel.

1. Press the  (Playback) button.
 - The last recorded image appears on the LCD monitor.
2. In  (Playback) mode, use  or  to select the desired images.
 - To view the previous image, press the  button.
 - To view the next image, press the  button.
3. Press the **MENU** button to access in PLAYBACK menu, then use  or  to select [RESIZE] and press the  button.
4. Use  or  to select the desired setting, then press the  button to confirm.





VIDEO MODE

Recording Video Clips

This mode allows you to record video clips with sound via built-in microphone.

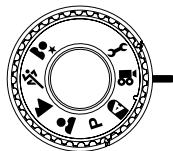





1. Rotate the mode dial to  mode and turn your camera on by pressing the power (ON/OFF) button.
2. Press the shutter button to start recording.
3. To stop recording, press the shutter button again.



- The zoom function of optical zoom (3x) can be activated before you start to record video clips.
- Pressing the  button switches the LCD monitor display mode. Each time you press the  button, the display changes in the following order: Focus Frame On → Indicators Off → Composition Line On → LCD Off.

Playing Back Video Clips

You can play back recorded video clips. A guide to operation appears on the LCD monitor during the video playback.

1. Press the  (Playback) button.
2. Use  or  to go through the images until the video clip you want to play back is displayed.
 - To view the previous image, press the  button.
 - To view the next image, press the  button.
3. Press the  button to start playing back the video clips.
 - To pause or resume video playback, press the  button again.



- The playback information displayed on the LCD monitor will disappear after seconds of time.
- The zoom function cannot be activated while playing the video clips back.
- To playback the video clips on the computer, we recommend you to use Windows Media Player 9.0 (WMP 9.0). You can download WMP version from the website at www.microsoft.com.

PLAYBACK MODE – ADVANCED FEATURES

Playing Back Still Images/Video Clips on TV

You can also playback your images on a TV screen. Before connecting to any device, make sure to select NTSC/PAL system to match the video output system of the video equipment you are going to connect to the digital camera, then turn all connected devices off.

1. Connect one end of the A/V cable to the A/V terminal of the digital camera.
2. Connect the other end to the A/V input socket of the TV set.
3. Turn the TV and digital camera on.
4. Playback the images/video clips.
 - The method of operation is the same as playing back still images and video clips on the digital camera.

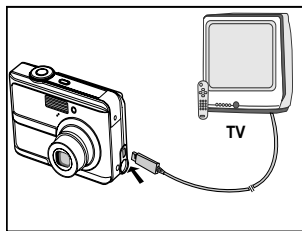





-
- The sound recorded with video clips can only be played back on TV or computers.













Deleting Images/Video Clips

Use this function to delete one or all images/video clips stored in the internal memory or memory card. Please note that the deleted images or video clips cannot be recovered. Exercise caution before deleting a file.

■ To delete the latest single image/video clip

1. Press the power (ON/OFF) button to turn on the power.
2. Press . When the delete message appears, use  or  to select [YES], then press the  button to delete the last image or video clip.
 - If you wish to cancel the deletion, select [NO].

■ To delete image/video clip by preference

1. Press the  (Playback) button.
 - The last recorded image appears on the LCD monitor, which can also be deleted directly by pressing .
2. Use  or  to select the image you want to delete.
3. Press the **MENU** button, then use  or  to select [DELETE] and press the  button.
4. Use  or  to select [THIS IMAGE] or [ALL IMAGES] by your preference, then press the  button.
5. When the delete message appears, use  or  to select [YES], then press the  button to confirm the deletion.
 - If you wish to cancel the deletion, select [NO].



















- Protected images cannot be deleted with the delete function.



Protecting Images/Video Clips

Set the data to read-only to prevent images from being erased by mistake.













1. Press the  (Playback) button.
 - The last recorded image appears on the LCD monitor.
2. In  (Playback) mode, use  or  to select the desired images.
 - To view the previous image, press the  button.
 - To view the next image, press the  button.
3. Press the **MENU** button, then use  to select [PROTECT] and press the  button.
4. Use  or  to choose the desired setting, then press the  button.
 - [PROTECT ONE]: Protect one image/movie.
 - [PROTECT ALL]: Protect all images/movies (at once).
5. Use  or  to select [LOCK], then press the  button to confirm.
 - Press the **MENU** button to return to the  (Playback) mode. The  indicator appears on the selected image.
 - If you wish to cancel the protect function, select [UNLOCK].









Setting the DPOF

DPOF (Digital Print Order Format) allows you to embed printing information on your memory card. By using DPOF, you can select an image to be printed and then specify how many prints or which image you would like. Take your memory card to a DPOF enabled printer that accepts memory cards. The DPOF/card-compatible printer will read the embedded information on the memory card and print your images as specified.

■ To configure print settings for a single image / all images.

Step	Figure	Procedure
1		Press the  (Playback) button, then use  or  to select the desired image you want to mark  . * The playback information displayed on the LCD monitor will disappear after seconds of time.
2		Press the MENU button. Use  or  to select [DPOF], then press the  button.
3		Use  or  to select by your preference, then press the  button. [ONE IMAGE]: To configure print settings for a single image. [ALL IMAGES]: To configure print settings for all images. [RESET ALL]: Returns all basic settings to the digital camera's default settings.

Step	Figure	Procedure
4		<p>Use ▲ or ▼ to select by your preference, then press the  button.</p> <p>[QUANTITY]: Allows you to select image quantity (0~10). Use ◀ or ▶ to set the image quantity.</p> <p>[DATE]: The date of recording can be printed directly on the images. Press the  button to choose [YES] or [NO] with ◀ or ▶.</p> <p>[RETURN]: To exit the mark function, use ▲ or ▼ to select [RETURN], then press the  button.</p>
5		<p>Press the MENU button to return to the image playback mode.</p> <p>* The  is marked on the displayed image.</p> <p>To unmark the  mark, go back to step 3 to select [RESET ALL] with ▲ or ▼.</p>



- Before you perform the DPOF settings on your camera, always remember to copy your images from the internal memory to an SD memory card first.
- The  print icon will appear on the monitor indicating images selected for printing.
- You cannot print movies.

Connecting to a PictBridge Compliant Printer

Even if you do not have a computer, you can connect the camera directly to a printer that supports PictBridge to perform image selection and printing using the camera monitor screen and controls. DPOF support also lets you specify which images you want to print and how many copies of each should be printed.

Connecting the camera to the printer

1. Rotate the mode dial to \mathcal{f} and turn your camera on by pressing the power (ON/OFF) button.
2. Press \blacktriangleright to select the [CUSTOM] menu, then use \blacktriangledown to select [USB].
3. Use \blacktriangle or \blacktriangledown to select [PRINT], then press the OK button.
4. Connect your camera and the printer via a supplied USB cable.
 - The screen turns off automatically and the setting screen will appear on the monitor after seconds of time.













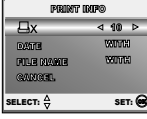

Printing images

When the camera is properly connected to a PictBridge compliant printer, the [PRINT MODE SELECT] screen is displayed on the monitor. Use \blacktriangle or \blacktriangledown to select the print mode.



- **In [PRINT] Mode:** Lets you print the specified image with PictBridge.

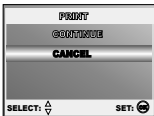





Step	Figure	Procedure
1	A screenshot of the camera's LCD menu showing the 'PRINT MODE SELECT' screen. The menu options are 'PRINT' and 'PRINT PAPER'. The 'PRINT' option is highlighted with a thick horizontal bar. At the bottom of the screen, there is a status bar with 'SELECT' and 'SET: OK'.	Use \blacktriangle or \blacktriangledown to select the [PRINT] mode, then press the OK button. * The [PRINT PAPER] screen is displayed.

Step	Figure	Procedure
2		<p>Use ▲ or ▼ to access in the selection of paper setting, then press the  button to confirm.</p> <p>[SIZE]: You may select the desired item depending on the type of printer being used.</p> <p>[BORDERLESS]: You may select the desired item depending on the type of printer being used.</p>
3		<p>Use ◀ or ▶ to select the image you want to print, then press ▼ to proceed more detailed settings.</p> <p>* The [PRINT INFO] screen is displayed.</p>
4		<p>Use ▲ or ▼ to select by your preference, then press the  button.</p> <p>[ X]: Specifies the number of prints. You can select the number up to 10.</p> <p>[DATE]: If you select WITH, images are printed with the date.</p> <p>[FILE NAME]: If you select WITH, images are printed with the file name.</p> <p>[CANCEL]: To cancel the print settings, use ▲ or ▼ to select [CANCEL].</p>
5		<p>After the step 4 finished, you can still use ◀ or ▶ to change the image by your preference, then press the  button to print.</p>

Step	Figure	Procedure
6	 A screenshot of a printer's menu. The word 'PRINT' is highlighted in the center. Below it, 'CANCEL' is visible. At the bottom, there are 'SELECT' and 'SET' buttons with directional arrows.	Use ▲ or ▼ to select [PRINT], then press the  button to confirm. * The TRANSFERRING screen is displayed.
7	 A screenshot of the 'TRANSFERRING' screen. It shows a camera icon, a printer icon, and a large 'Z' in the center. Below the icons, there is a progress bar and the text 'TRANSFERING'. At the bottom right, there is a 'CANCEL' button with an OK icon.	This starts printing and displays the message "TRANSFERRING" on the monitor screen. The message will disappear after the printing finished.
	 A screenshot of the printer's menu. 'CANCEL' is highlighted in the center. Above it, 'CONTINUE' is visible. At the bottom, there are 'SELECT' and 'SET' buttons with directional arrows.	* To cancel printing: Pressing the  button during print data transfer displays the screen for selecting whether to [CONTINUE] or [CANCEL] printing.

- **In [PRINT ORDER] Mode:** This function only lets you print the specified image based on the previous DPOF settings.

Step	Figure	Procedure
1	 A screenshot of the printer's menu. 'PRINT ORDER' is highlighted in the center. Above it, 'PRINT' and 'PRINT ORDER SELECT' are visible. At the bottom, there are 'SELECT' and 'SET' buttons with directional arrows.	Use ▲ or ▼ to select the [PRINT ORDER] mode, then press the  button. * The [PRINT PAPER] screen is displayed.

Step	Figure	Procedure
2		<p>Use ▲ or ▼ to access in the selection of paper setting, then press the  button to print.</p> <p>[SIZE]: You may select the desired item depending on the type of printer being used.</p> <p>[BORDERLESS]: You may select the desired item depending on the type of printer being used.</p>
3		<p>Use ▲ or ▼ to select [PRINT], then press the  button to confirm.</p> <p>* The TRANSFERRING screen is displayed.</p>
4		<p>This starts printing and displays the message "TRANSFERRING" on the monitor screen. The message will disappear after the printing finished.</p> <p>* To cancel printing: Pressing the  button during print data transfer displays the screen for selecting whether to [CONTINUE] or [CANCEL] printing.</p>

TRANSFERRING FILES FROM YOUR DIGITAL CAMERA TO COMPUTER

After using USB cable to establish a USB connection between the camera and your computer, you can use your computer to share recorded images or video clips with your family or friends via e-mail or post them on the Web. In order to do this, you must install the USB driver onto your computer first. Note that before you begin to install the software, you need to check your system according to the table as shown below.

	System Requirements (Windows)	System Requirements (Macintosh)
CPU	Pentium III 600 MHz processor or higher	PowerPC G3/G4
Operating System	Windows 98/98SE/ME/2000/XP	OS 9.0 or higher
RAM	32MB (64MB RAM recommended)	32MB (64MB RAM recommended)
Hard Disk Space	128MB hard disk space	128MB hard disk space
Required Devices	A CD-ROM drive An available USB port	A CD-ROM drive An available USB port
Display	Color Monitor (800x600, 24-bit or higher recommended)	Color Monitor (800x600, 24-bit or higher recommended)

Step I: Install the USB driver

■ Installation on Windows 98 & 98SE

The USB driver on the supplied CD-ROM is exclusively for Windows 98 and 98SE. Windows 2000/ME/XP users need not install the USB driver.

1. Insert the enclosed CD-ROM into your CD-ROM drive.
2. When the welcome screen appears, click **“INSTALL USB DRIVER”**.
Follow the on-screen instructions to complete the installation.
3. After the USB driver has been installed, restart your computer.



■ Installation on MAC OS 9.0

For Mac OS 9.0 or higher, the computer will automatically recognize the digital camera and load its own USB drivers.

Step 2: Connect the digital camera to your computer

1. Rotate the mode dial to \mathcal{f} and turn your camera on by pressing the power (ON/OFF) button.
2. Press \blacktriangleright to select the [CUSTOM] menu, then use \blacktriangledown to select [USB].
3. Use \blacktriangledown to select [PC], then press the OK button.
4. Connect one end of the USB cable to an available USB port on your computer.
5. There will be a new “Removable Disk” icon detected in “My Computer”, in which contains your recorded images or video clips.
(For Mac users, double-click [untitled] or [unlabeled] disk drive icon on our desktop.)

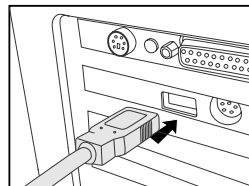
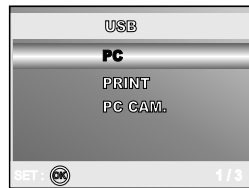

Step 3: Download images or video clips

When the digital camera is turned on and connected to your computer, it is considered to be a disk drive, just like a floppy disk or CD. You can download (transfer) images by copying them from the “Removable disk” (“untitled” or “unlabeled” disk on a Macintosh) to your computer hard drive.

■ Windows

Open the “removable disk” and double click on the DCIM / DSCIM folder to open it to find more folders. Your images are inside these folder(s). Select the desired still images or video clips and then choose “Copy” from the “Edit” menu. Open the destination location (folder) and choose “Paste” from the “Edit” menu. You may also drag and drop image files from the digital camera to a desired location.

■ Macintosh

Open the “untitled” disk icon, and the destination location on your hard disk. Drag and drop from the digital camera to the desired destination.



- Memory card users may prefer to use a memory card reader (highly recommended).
- Video playback application is not included with the package. Make sure that video playback application has been installed in your computer.

EDITING SOFTWARE INSTALLATION

Installing Photo Explorer

Ulead® Photo Explorer provides a simple and efficient way to transfer, browse, modify and distribute digital media. Acquire photos, video or sound clips from various digital device types and easily browse or add personal descriptions; make timely modifications; or distribute the media through the medium of your choice: E-mail, Print, Slideshow Presentations. It is an indispensable all-in-one tool for owners of digital cameras, WebCams, DV camcorders, scanners, or anyone who strives to effectively organize a large collection of digital media.

1. Insert the enclosed CD-ROM into your CD-ROM drive.
2. When the welcome screen appears, click **“INSTALL Photo Explorer 8.0”**. Follow the on-screen instructions to complete the installation.



- For more information about the operation of Photo Explorer application software, refer to its respective help documentation.
- For Windows 2000/XP users, please make sure to install and use the Photo Explorer in “Administrator” mode.
- Photo Explorer is not supported on the Mac. iPhoto or iPhoto2 is recommended.

Installing Photo Express

Ulead® Photo Express is complete photo project software for digital images. The step-by-step workflow, visual program interface, and in-program help assist users in creating exciting photo projects. Acquire digital photos effortlessly from digital cameras or scanners. Organize them conveniently with the Visual Browse mode. Use hundreds of ready-to-use templates such as albums, cards, posters, slideshows, and more. Edit and enhance images with photo editing tools, photographic filters, and special effects. Embellish projects by adding creative design elements such as frames, callouts, and stamp objects. Share results with family and friends via e-mail and multiple print options.

1. Insert the enclosed CD-ROM into your CD-ROM drive.
2. When the welcome screen appears, click **“INSTALL Photo Express 5.0”**. Follow the on-screen instructions to complete the installation.



- For information on how to use Photo Express to edit and retouch your recorded images, please refer to its online help.
- For Windows 2000/XP users, make sure to install and use the Photo Express while logged in as a user with an Administrator account.
- Photo Express is not supported on the Mac.

USING THE DIGITAL CAMERA AS A PC CAMERA

Your digital camera can act as a PC camera, which allows you to videoconference with business associates, or have a real-time conversation with friends or family. To use the digital camera for videoconferencing, your computer system must include the items as below:

- Microphone
- Sound card
- Speakers or headphones
- Network or Internet connection



- Video conferencing (or video editing) software is not included with the digital camera.
- This mode is not supported for Mac.

Step 1: Install the PC camera driver

The PC-camera driver included in the CD-ROM is exclusively for Windows. The PC camera function is not supported for Mac platforms.

1. Insert the enclosed CD-ROM into your CD-ROM drive.
2. When the welcome screen appears, click “ **DRIVER For PC CAM** ”.
Follow the on-screen instructions to complete the installation.
3. After the driver installation is completed, restart your computer.



Step 2: Connect the digital camera to your computer

1. Rotate the mode dial to **f** and turn your camera on by pressing the power (ON/OFF) button.
2. Press **▶** to select the [CUSTOM] menu, then use **▼** to select [USB].
3. Use **▲** or **▼** to select [PC CAM.], then press the **OK** button.
4. Connect one end of the USB cable to an available USB port on your computer.
5. Position the digital camera steadily on top of your computer monitor or use a tripod.



- When using this digital camera as a PC camera, it is necessary to install the battery into the digital camera.

Step 3: Run your application software (i.e. Windows NetMeeting)

To use Windows NetMeeting for videoconferencing:

1. Go to **Start → Programs → Accessories → Communications → NetMeeting** to launch the NetMeeting program.
2. Click the Start Video button to view live video.
3. Click the Place Call button.
4. Type the e-mail address or the network address of the computer that you are calling.
5. Click Call. The person that you are calling must also have Windows NetMeeting running and be willing to accept your call to start the videoconference.



- The video resolution for videoconferencing applications is generally 320 x 240.
- For more information about the operation of videoconference application software, refer to its respective help documentation.

MENU OPTIONS



Camera Menu









This menu is for the basic settings to be used when capturing still images.









1. Rotate the mode dial to **A**, **P**, **Ⓜ**, **▲**, **⚡** or **Ⓜ*** and turn your camera on.
2. Press the **MENU** button, then use **◀** or **▶** to select the [PICTURE] / [FUNCTION] / [AE/AWB] menu.
 - In **A** (Auto) Mode, press the **MENU** button to access in menu directly.
3. Press **▲** or **▼** to select the desired setting, then press the **OK** button.
4. To exit from the menu, press the **MENU** button.











■ In A (Auto) Mode









Item	Functional Description
IMAGE SIZE 	Sets the size of the image that will be captured. <ul style="list-style-type: none">* SM 2560x1920* SM 2048x1536* 1.5X 1280x960* 0.5X 640x480
QUALITY 	Sets the quality (compression rate) at which the image is captured. <ul style="list-style-type: none">* ★★ FINE* ★ NORMAL* ★ ECONOMY

Item	Functional Description
FOCUS 	You can take images with the distance to the subject set by auto focus, macro or infinity. *  AUTO *  MACRO *  INFINITY
CAPTURE MODE 	Sets the recording method at the time of taking pictures. *  SINGLE *  BURST *  AEB

■ In P, , ,  or  Mode

PICTURE	Item	Functional Description
	IMAGE SIZE 	Refer to "Camera Menu - In A (Auto) Mode" in LIST OF MENU OPTIONS.
	QUALITY 	Refer to "Camera Menu - In A (Auto) Mode" in LIST OF MENU OPTIONS.
	SHARPNESS 	Sets the level of image sharpness. *  LOW *  MEDIUM *  HIGH

PICTURE	Item	Functional Description
	COLOR 	Sets the color of the image that will be captured. *  FULL COLOR *  BLACK & WHITE *  SEPIA
	SATURATION 	To capture an image, your camera offers you three different degrees of color to match with your preference. Your images will demonstrate different impression by selecting different degrees of color. This is called "Saturation". *  HIGH *  MEDIUM *  LOW
FUNCTION	Item	Functional Description
	FOCUS 	Refer to "Camera Menu - In A (Auto) Mode" in LIST OF MENU OPTIONS.
	CAPTURE MODE 	Refer to "Camera Menu - In A (Auto) Mode" in LIST OF MENU OPTIONS.
	METERING 	Refer to section in this manual titled "Selecting the Metering Mode" for further details.



AE/AWB	Item	Functional Description
	EXPOSURE 	Sets to obtain the correct exposure when the subject is much brighter or darker than the background. The EV compensation value can be set in the range from -2.0EV to +2.0EV.
	W. BALANCE 	Sets the white balance photographing under a variety of lighting conditions and permits photographs to be taken that approach the conditions that are seen by the human eye. <ul style="list-style-type: none"> * AUTO *  DAYLIGHT *  CLOUDY *  SUNSET *  TUNGSTEN *  FLUORESCENT
	ISO 	Sets the sensitivity for taking pictures. When the sensitivity is raised (and the ISO figure is increased), photography will become possible even in dark locations, but the more pixilated (grainer) the image will appear. *AUTO / 50 / 100 / 200

Video Menu

This menu is for the basic settings to be used when recording video clips.





1. Rotate the mode dial to  mode and turn your camera on.
2. Press the **MENU** button, then use **▼** to select the [COLOR].
3. To exit from the playback menu, press the **MENU** button.



Item	Functional Description
COLOR 	REFER TO "Camer Menu-In In P ,  ,  ,  or  Mode" of MENU OPTIONS.









Playback Menu

In the  (Playback) menu, set which settings are to be used for playback.



1. Press the  (Playback) button.
 - The last recorded image appears on the LCD monitor.
2. Press the **MENU** button, then use **▲** or **▼** to select the desired setting and press the  button.
3. To exit from the playback menu, press the **MENU** button.

Item	Functional Description
DELETE 	Delete one or all images you captured. * Refer to section in this manual titled is "Deleting Images/Video Clips" for further details.
SLIDE SHOW 	You can play back recorded images in order with a selected interval time. This function is useful for checking your images or for presentations, etc. Refer to section in this manual titled "Slideshow Display" for further details. * 3 SEC. / 5 SEC. / 10 SEC.
PROTECT 	Set the data to read-only to prevent images from being erased by mistake. Refer to section in this manual titled "Protecting images/Video clips" for further details. * Refer to section in this manual titled is "Protecting Images/Video Clips" for further details.

Item	Functional Description
<p data-bbox="131 155 229 174">QUALITY</p> <p data-bbox="131 194 229 213">CHANGE</p> 	<p data-bbox="294 155 1132 174">Change to set the desired quality (compression rate) at which the image is captured.</p> <ul style="list-style-type: none"> <li data-bbox="294 188 425 207">* ★★ FINE <li data-bbox="294 232 468 250">* ★★ NORMAL <li data-bbox="294 275 488 294">* ★ ECONOMY
<p data-bbox="131 314 216 333">RESIZE</p> 	<p data-bbox="294 314 687 333">Changes the size of a recorded image.</p> <ul style="list-style-type: none"> <li data-bbox="294 352 491 370">*  2560x1920 <li data-bbox="294 389 491 408">*  2048x1536 <li data-bbox="294 426 478 445">*  1280x960 <li data-bbox="294 464 466 482">*  640x480
<p data-bbox="131 518 194 536">DPOF</p> 	<p data-bbox="294 518 1132 625">Allows you to select the desired pictures to be printed and set the number of prints and date displayed in DPOF format. You can print images easily just by inserting the memory card to a DPOF-compatible printer or a print shop. Refer to section in this manual titled "Setting the DPOF" for further details.</p>
<p data-bbox="131 642 234 692">COPY TO CARD</p> 	<p data-bbox="294 642 1118 723">Allows you to copy your files from the digital camera's internal memory to a memory card. Of course, you can only do this if you have a memory card installed and some files in internal memory.</p> <p data-bbox="294 731 408 750">* YES / NO</p>



Setup Menu

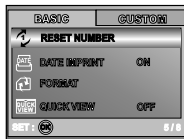



This feature allows you to set up the default settings by preference for using your camera.







1. Rotate the mode dial to \mathcal{S} (Setup) mode and turn your camera on.
2. Press \blacktriangleleft or \blacktriangleright to select the [BASIC] / [CUSTOM] menu.
3. Use \blacktriangle or \blacktriangledown to select the desired option item, then press the OK button.
4. To exit from the setup menu, rotate the mode dial to other desired mode again.

■ BASIC settings

Item	Functional Description
BEEPER 	This sets whether or not to mute the startup sound and the camera sound each time you press the camera button. * LOUDER / SOFT / OFF
POWER OFF 	If no operation is performed for a specific period of time, the power to the camera is automatically turned off. This feature is useful to reduce battery wear. * 2 MIN. / 3 MIN. / 5 MIN. / OFF
DIGITAL ZOOM 	This sets whether or not to use digital zoom at the time of photography. * ON / OFF

Item	Functional Description
SET TO DEFAULT 	Returns all basic settings to the digital camera's default settings. The time setting will not be reset. * YES / NO
RESET NUMBER 	Set whether or not to reset the file number when you take photographs. This creates a new folder. The captured images are recorded to the newly created folder from number 0001. If you want to reset the file number, be sure that no images are recorded in the internal memory or the SD memory card. * YES / NO
DATE IMPRINT 	The date of recording can be printed directly on the still images. This function must be activated before the image is captured. * ON / OFF
FORMAT 	Erases all images and reformats the SD card loaded in your camera. Protected images are also erased. SD card cannot be formatted if it is write-protected. Refer to section in this manual titled "Formatting an SD Memory Card or Internal Memory" for further details. * YES / NO
QUICK VIEW 	Set to display a photographed image on LCD monitor immediately after you have taken the shot. * ON / OFF

■ CUSTOM settings

Item	Functional Description
DATE & TIME 	This sets the date and the time. Refer to section in this manual titled "Setting the Date and Time" for further details. * Y/M/D * D/M/Y * M/D/Y
TV 	Sets video output system of the video equipment that you are going to connect to the camera. * PAL / NTSC
LANGUAGE 	Sets the language that is displayed on the LCD monitor. Refer to section in this manual titled "Choosing the Screen Language" for further details. * ENGLISH / FRANÇAIS / DEUTSCH / ESPAÑOL/ ITALIANO / 繁体中文 / 简体中文
LCD BRIGHTNESS 	This sets the brightness of the LCD monitor. The adjustment range is from -5 to +5.
USB 	Select to choose one of the following modes for further settings. * PC / PRINT / PC CAM.

CONNECTING THE DIGITAL CAMERA TO OTHER DEVICES

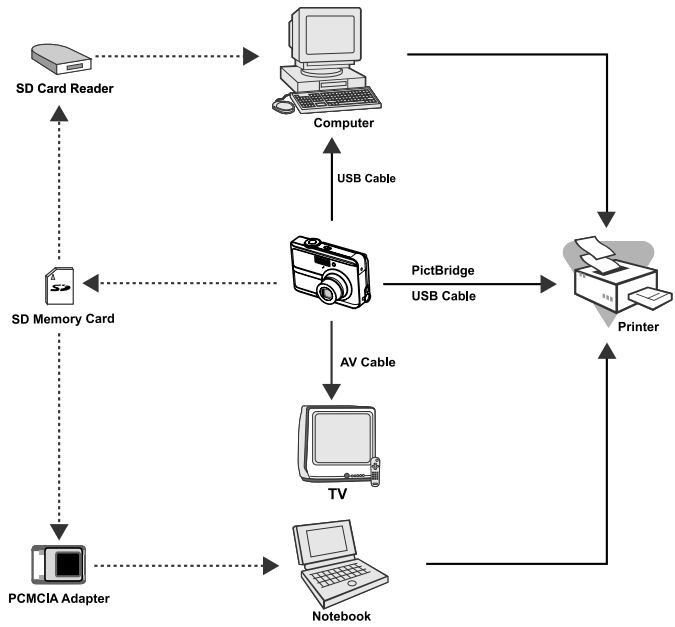







SPECIFICATIONS

Item	Description
Image Sensor	CCD
Effective pixels	5.0 Mega pixels
Image size	Still image: 2560 x 1920, 2048 x 1536, 1280 x 960, 640 x 480 Video clip: 320 x 240
Image quality	Still image: Fine, Normal, Economy Movie image: Economy
Recording media	16MB internal memory SD memory card (up to 512 MB)
File format	Motion JPEG (AVI); Picture Bridge support; PC-CAM support (QVGA around 20 f/s)
Lens	F-no.: Wide: 2.8 / Tele: 4.8 Focal length: 5.4mm-16.2mm (Equivalent to 35mm Camera: 32~96 mm)
Focus range	Normal : 0.5 m-infinity Macro : 0.06 m-infinity (Wide) / 0.35 m-infinity (Tele)
LCD monitor	2.5" LTPS color LCD High-resolution 115K pixels display
Self-timer	10 sec delay, 2 sec delay, 10+2 sec delay
Exposure compensation	-2.0EV~ +2.0EV (in 0.3EV increments)
White balance	Auto, Daylight, Cloudy, Sunset, Tungsten, Fluorescent
ISO	Auto, 50, 100, 200
Interface	DC-IN jack, USB connector, A/V terminal
Power	2 x AA Alkaline batteries AC-DC Adapter (3V/2.5A)
Dimension	Approx. 91 x 61.9 x 27 mm
Weight	Approx. 140g (without batteries and the SD memory card)

* Design and specifications are subject to change without notice.

APPENDIX

■ Troubleshooting Guide

Symptom	Possible causes	Solutions / Corrective Actions
Power does not turn on.	<ul style="list-style-type: none">* The battery has run out.* The battery is not oriented correctly.* The battery cover is not closed properly.* The AC power adapter (optional) is disconnected.	<ul style="list-style-type: none">* Load new or fully charged battery.* Load the battery in the correct direction.* Close the battery cover correctly.* Properly connect the AC power adapter.
Camera suddenly powers down.	<ul style="list-style-type: none">* The function of POWER OFF in  (Setup) mode has been activated.* The battery has run out.	<ul style="list-style-type: none">* Set the option of POWER OFF to OFF.* Turn the power back on or charge the battery.
Image is not captured when the shutter button is pressed.	<ul style="list-style-type: none">* The camera is in  (Play) mode.* Memory is full.	<ul style="list-style-type: none">* Rotate the mode dial to A, P, , ,  or .* Transfer the desired files to your computer and then delete unnecessary files, or use a different memory card.
Flash does not fire.	<ul style="list-style-type: none">* NO FLASH is selected in flash mode.* The camera is in BURST/AEB/  (Video) mode.	<ul style="list-style-type: none">* Select a different flash mode.* Select [SINGLE] in the capture mode .
Continuous shooting is not possible.	<ul style="list-style-type: none">* The capacity of the built-in memory or SD memory card is full.	<ul style="list-style-type: none">* Insert a new SD memory card.
Cannot transfer files over a USB connection.	<ul style="list-style-type: none">* USB cable is not connected securely.* USB driver is not installed.* Camera is turned off.	<ul style="list-style-type: none">* Check all connections.* Install the USB driver on your computer.* Turn on the camera.



Attention: Your product is marked with this symbol. It means that used electrical and electronic products should not be mixed with general household waste. There is a separate collection system for these products.

A. Information on Disposal for Users (private households)

1. In the European Union

Attention: If you want to dispose of this equipment, please do not use the ordinary dust bin!

Used electrical and electronic equipment must be treated separately and in accordance with legislation that requires proper treatment, recovery and recycling of used electrical and electronic equipment.

Following the implementation by member states, private households within the EU states may return their used electrical and electronic equipment to designated collection facilities free of charge*. In some countries* your local dealer may also take back your old product free of charge if you purchase a similar new one.

*) Please contact your local authority for further details.

If your used electrical or electronic equipment has batteries or accumulators, please dispose of these separately beforehand according to local requirements.

By disposing of this product correctly you will help ensure that the waste undergoes the necessary treatment, recovery and recycling and thus prevent potential negative effects on the environment and human health which could otherwise arise due to inappropriate waste handling.

2. In other Countries outside the EU

If you wish to discard this product, please contact your local authorities and ask for the correct method of disposal.

For Switzerland: Used electrical or electronic equipment can be returned free of charge to the dealer, even if you don't purchase a new product. Further collection facilities are listed on the homepage of www.swico.ch or www.sens.ch.

B. Information on Disposal for Business Users

1. In the European Union

If the product is used for business purposes and you want to discard it: Please contact your local dealer who will inform you about the take-back of the product. You might be charged for the costs arising from take-back and recycling. Small products (and small amounts) might be taken back by your local collection facilities.

For Spain: Please contact the established collection system or your local authority for take-back of your used products.

2. In other Countries outside the EU

If you wish to discard of this product, please contact your local authorities and ask for the correct method of disposal.